



Dakota

DILWORTH
DEVELOPMENT, INC.

SUMMARY

Bedrooms: 4-5
Bathrooms: 3
Floors: 2

AREA

Main Level 2,183 s.f.
Upper Level 713 s.f.
Total: 2,896 s.f.

DIMENSIONS

Width: 79'-10"
Depth: 58'-10"



MAIN LEVEL

SEE NEXT PAGE FOR PLAN OPTIONS

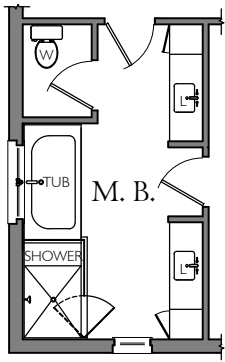

OPT. MST. BATH

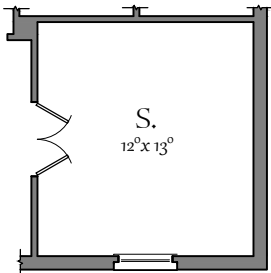

OPT. STUDY

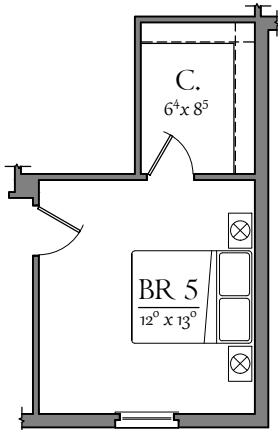

OPT. BD RM 5

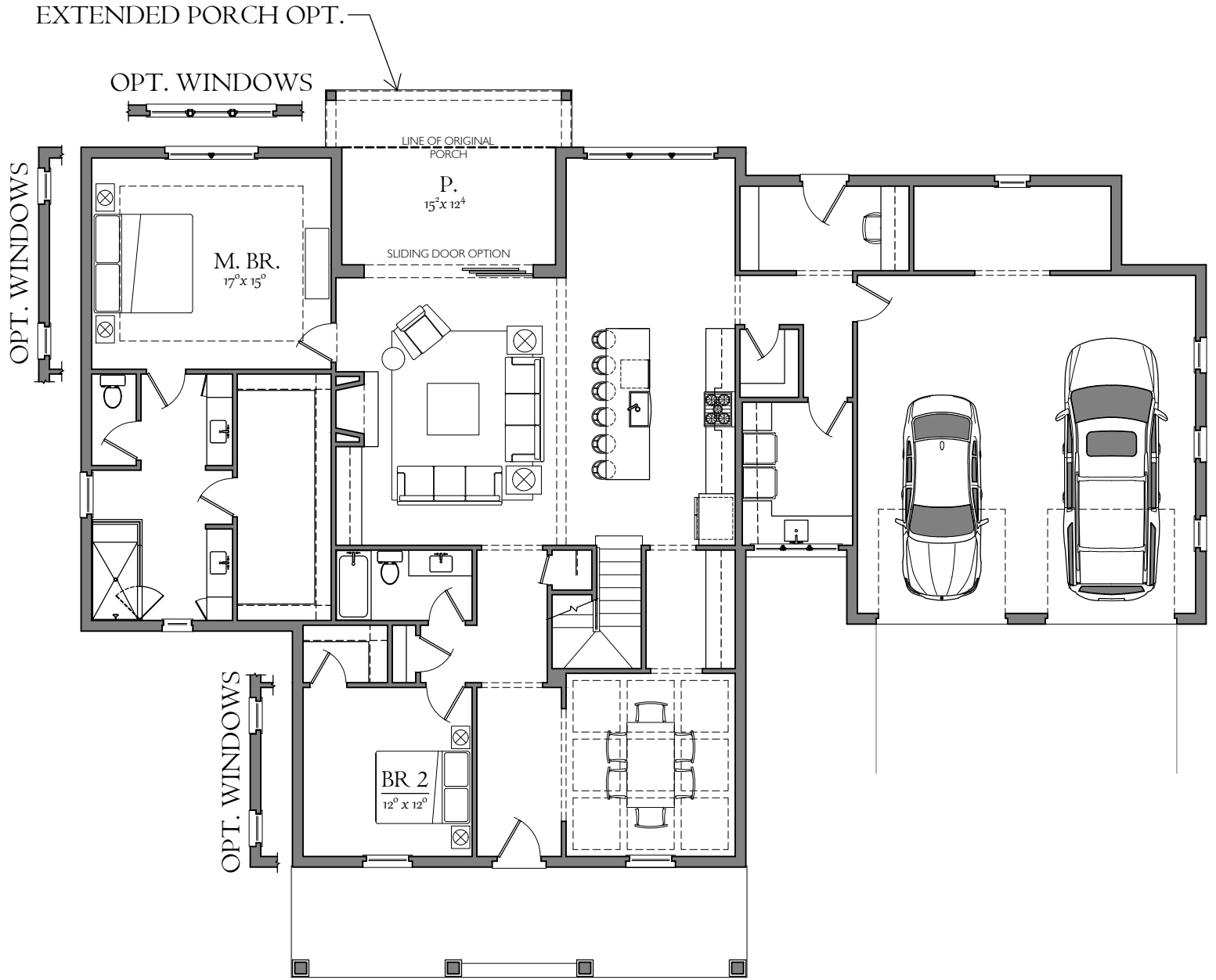

MAIN LEVEL

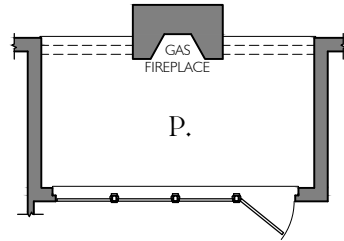

OPTIONAL PORCH FIREPLACE

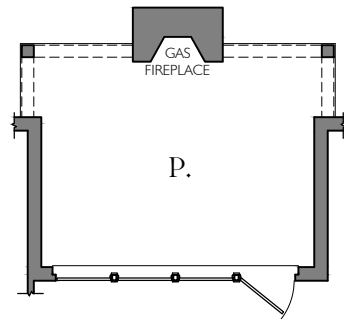

OPTIONAL PORCH FIREPLACE -EXTENDED

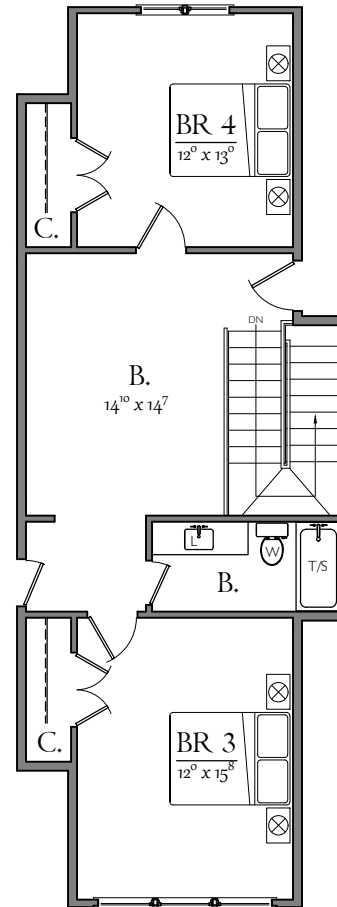

UPPER LEVEL